



**YES,  
WE  
ACT**



# CONTENTS

... through dialogue  
and innovation,  
as the Brückner  
Group and together  
with you!

p. 6 **#circular**  
at Brückner Maschinenbau

p. 14 **#digital**  
with Brückner Servtec

p. 22 **#career**  
at Kiefel

p. 30 **#creative**  
thanks to PackSys Global

# FOREWORD

Dear readers,

Yes or no? Or yes AND no? There's not always a clear answer to the complex questions and challenges currently facing us. This makes a clear stance, a clear commitment and a clear promise all the more important. And this is why we say yes. Yes to assuming responsibility: for our employees, customers and partners as well as for our environment. Plastic and sustainability are often presented as incompatible. But they're not, as we want to demonstrate.

We accept the challenge of establishing plastic as a sustainability driver of the circular economy. As the Brückner Group, we're in a good position to do this: with four highly specialised lead companies, we can impact decisively on the future. As a technology and market leader, we're able and willing to make a difference – and this comes with great responsibility.

“

## Yes, we're assuming responsibility!

Maximilian Schneider

We find motivation in this sense of responsibility, which is why we say “Yes!” with such enthusiasm. We're convinced that together we'll find the right solutions for the future. Even now, we have solutions at the ready. This year, we'd like to demonstrate our commitment and enthusiasm in this sustainability magazine, showing you why we say “Yes!” with such determination and what we're doing to be part of the solution. Showing you who is responsible for driving creativity, development and innovation at Brückner Maschinenbau, Brückner Servtec, Kiefel and PackSys Global, which solutions they're creating and how they're envisioning the future.

We want, through this magazine, to acknowledge each one of these people. The stories we showcase also demonstrate the expectations we put on ourselves of continuous improvement. This is our way of moving, step by step, towards a more sustainable future.



Dr. Axel von Wiedersberg (CEO) and Maximilian Schneider (CFO) of Brückner Group GmbH

“

## Sustainability commitment requires conviction and purpose – at the Brückner Group, we have both.

Dr. Axel von Wiedersberg



## “No need to reinvent the wheel – just find new solutions!”

Plastic is the *bête noire* of the modern age, because more often than not, it doesn't remain in the cycle. The cause? Insufficient collection, sorting and recycling infrastructures – and a lack of data. R-Cycle and Brückner Maschinenbau have therefore jointly developed the Digital Product Passport. Here, Michael Baumeister and Benedikt Brenken share their views on the opportunities, challenges and future of recycling plastic packaging.

Plastic plays a decisive role in a functioning circular economy. Key factors here are collection, sorting and recycling infrastructures.

The R-Cycle initiative, with the participation of Brückner Maschinenbau, is working on the development of an open and globally applicable traceability standard for plastic packaging. A conversation with Michael Baumeister, Managing Director Technology & Logistics at Brückner Maschinenbau, and Dr Benedikt Brenken, Director of R-Cycle.

### What are the requirements of the circular economy – and how do plastics fit in?

**Michael Baumeister:** “It needs recyclable products that can be collected, sorted, recycled and fed back into the cycle. A circular economy is a must for the EU – enabled by digitalisation. How do plastics fit in? It's as if they were made for recycling. Also, innovations such as mono-material structures made of only one type of plastic improve packaging recyclability.”

**Benedikt Brenken:** “Information is needed about the options for recycling and further processing of raw packaging material. R-Cycle focuses on this data exchange to enable improved sorting.”

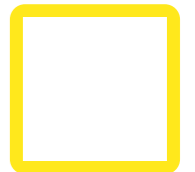

You can find out more about R-Cycle here.

#circular

*"R-Cycle's open approach can be credited for facilitating the integration of all stakeholders along the life cycle of plastics."*



# Be open!

**Benedikt Brenken**  
Director R-Cycle

Brückner Maschinenbau & R-Cycle: recognising and recycling plastic packaging

#### What exactly is your approach?

#### How does the Digital Product Passport work?

**Benedikt Brenken:** "The Digital Product Passport essentially consists of three elements: a globally unique ID number, similar to a car registration number; a data set with relevant information, in this instance, recycling-relevant information; and a suitable marker linking ID number and product, like a licence plate. For the ID number and data, we rely on an open, global and established standard. In terms of labelling, R-Cycle is an open system that is compatible with various labelling technologies. Depending on specific requirements, this can range from digital watermarks to traditional bar codes or QR codes."

#### What distinguishes R-Cycle from other sustainability initiatives?

**Michael Baumeister:** "The great advantage of this initiative is that anybody can directly use the worldwide open standard and participate. We're not reinventing the wheel, but we are creating new solutions. Also, thanks to R-Cycle, even the tiniest shreds of packaging can be fed back into the correct recycling stream. That used to be the major flaw in the sorting process, but it has become possible now due to the link between information and product. No matter how small, it can be identified and recycled."

#### Speaking of recycling: are the mono materials mentioned earlier the solution of the future?

**Michael Baumeister:** "We're resolutely pushing the concept of mono-material structures, although the market is nascent. They're an important lever for increased recyclability and thus a functioning circular economy. Are they the only solution? I doubt it, as recycling processes are constantly evolving. And even with digital solutions like R-Cycle, we're only seeing the beginning of an exciting development."

#### Where do we go from here?

#### What are the next steps?

**Benedikt Brenken:** "If we want to bring new members up to the same level as experienced partners such as Brückner Maschinenbau, we need to keep developing our structures and processes. What's more, we want to implement further applications with the Digital Product Passport. The way we see it, future legislation, such as the demand for a Digital Product Passport, isn't a threat, but an opportunity. And we'd like to be involved in shaping it."

**Michael Baumeister:** "This is also why at R-Cycle we have a small team working on new applications and possibilities: so that additional data such as the carbon footprint can be incorporated or shoppers can find out immediately in the supermarket which packaging is recyclable. This level of transparency means identifying not only plastics but also all other materials. For this we need to involve other partners, sectors and companies: to find solutions with which we can drive sustainability towards the circular economy."



*"We're actively working towards a circular economy, together with R-Cycle - and with our innovations in mono materials."*

# Innovation!

**Michael Baumeister**

Managing Director Technology & Logistics at Brückner Maschinenbau



# 2020

saw the founding of the R-Cycle initiative, by Brückner Maschinenbau among others.

Technical infrastructure development and testing have been completed successfully.



**Innovations** such as the Digital **Product Passport** can also be transferred to other sectors.

Brückner Maschinenbau and R-Cycle are closing the plastics cycle along the entire value chain.







# In the spotlight: sustainability at Brückner Maschinenbau



Brückner Maschinenbau has always been aware of the many responsibilities it bears when it comes to sustainability: for its site, for its employees, with regard to energy-saving machine technologies and the development of recyclable films. To name a few examples:

- Company kindergarten for over 30 years
- Organically certified Brückner canteen
- Worldwide unique technology centre, also for research on bio-polymers
- Digital “Brückner ONE” platform for raw material and energy efficient film production
- Active membership in circular economy collaborations and initiatives



## Not new, but better!

The older a machine is, the less efficient it becomes. And exactly here Brückner Servtec comes in – by combining three digital and mechanical engineering solutions in one application: increased life time of the line, more resource-efficient production, and digital maintenance. This is what sustainability made in Siegsdorf looks like and how it works all around the globe.

Brückner Servtec is driving sustainability through digital and mechanical engineering solutions, leading customers into the future through artificial intelligence.

Plastic and sustainability? A great match, thinks Markus Gschwandtner, Managing Director at Brückner Servtec: “40 percent of food worldwide is spoiled because it’s not packaged properly. Plastic packaging makes food more durable and also protects it during transport.” Brückner Servtec offers both service and upgrade solutions for film stretching lines, allowing customers to improve product recyclability.

The Siegsdorf-based company develops solutions for mono materials, amongst others. For future technologies of this type, it relies on research and innovation and offers a diverse product portfolio, as different countries call for different materials. Polyester, for example, is big in India, while PE is the material of choice in Europe and PP in the US. While the global market for mono-material structures in packaging is still in its infancy, Brückner Servtec is already enabling customers to take steps towards the future.

Brückner Servtec believe in collaboration and, together with their customers, press exactly the right buttons for greater sustainability. Their approach is not a one-size-fits-all: “We find out from our customers what their aims and visions are, and then support them in achieving precisely those”, Markus Gschwandtner explains.

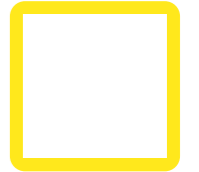

Stay up to date with the Brückner TEC TALKS.

#digital



To this end, Brückner Servtec optimises existing production lines in a way that brings about three immediate benefits. First, companies can switch to mono-material products after installing individual upgrades. Second, the life of the line is extended. And third, maintenance and services are offered digitally:

“For our customers, convenience is paramount. So we’re constantly digitalising our services and processes”, explains Julia Spannring, Business Development project manager for digitalisation projects. “It makes processes easier and is also more sustainable. In the past, for example, spare parts catalogues for production lines were sent out as paper copies, then CDs or USB sticks. Any changes meant that we had to send it all out again.” This service has been digitalised for quite some time now – and is also part of the Brückner ONE digital service platform. Containing four modules, it provides customer support for all aspects of their lines: requests for support and spare parts, communication and documentation – and all to the highest security standards.

This allows Brückner Servtec to support customers from all around the world without delays, travel or entailing any additional CO<sub>2</sub> emissions. One such customer is a global leader in packaging film manufacturing and has already connected 22 of its 27 production lines worldwide with Brückner ONE. In addition to this digital service and as one example out of many projects, Brückner Servtec comprehensively rebuilt an 18-year-old BOPP line for the same company last year.

How exactly did Brückner go about this – and how is the company driving sustainability in this way?

**01 Raw material handling system / direct fluff feeding**

Enables waste produced in the manufacturing process to be fed back into the cycle directly on site. This reduces waste and saves energy. It also allows the processing of new raw materials and recycled materials.

**02 Extrusion system**

Raw material for films is supplied in granules and melted in an extruder. The newly used twin screws consume less energy and are more efficient. The result? Better quality, less waste and the option of processing new raw materials.

**03 Direct drives**

Direct drives replace motors with gears. This saves electricity and leads to better quality, more precise work and new products. In requiring less maintenance, it increases uptime (the time during which the system is in operation).

**04 IPC conversion**

The integrated process control (IPC) controls the entire production line. Using IPC conversion, Brückner Servtec ran a comprehensive technology update on the line, thus making it ready for connection to new digital solutions.

**05 Predictive maintenance**

The update means that customers currently already know the dates for future maintenance work on their lines. This allows for better coordinated and optimised work processes.

**03**

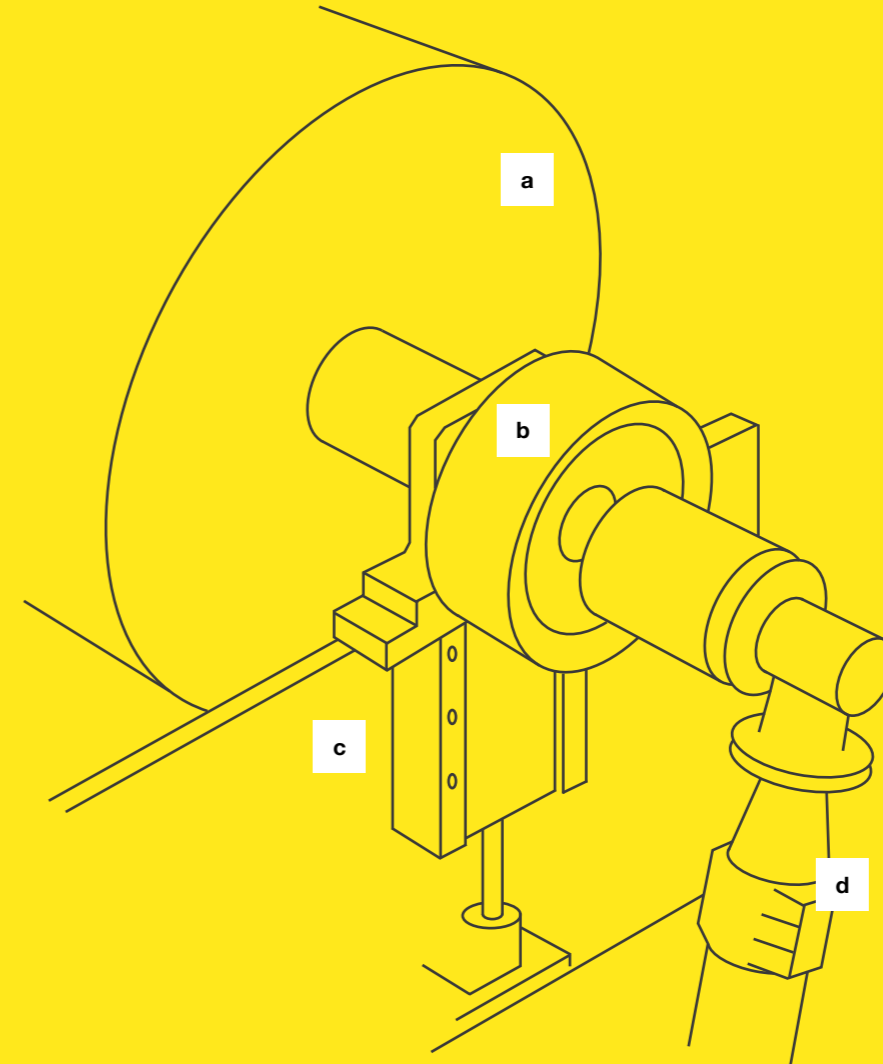

To move into the future with the line built in 2003, Brückner Servtec made five decisive changes. This illustration shows the direct drive and its components. Point 03 explains its role with regard to sustainability.

- a Cooling**
- b Direct drive**
- c Frame**
- d Cooling water inlet**

With such upgrades, Brückner Servtec enables a production line life which is on average 15 years longer and involves lower resource consumption. Existing lines can also be optimised to produce mono-material films in addition to conventional laminated films. New raw materials, including recycled materials, can also be processed. This prepares film manufacturers perfectly for the future. The currently existing political pressure towards greater sustainability calls for a change in thinking as well as continuous development.

For this reason, Brückner Servtec tests and works on new solutions, to make the future more sustainable: "We're using artificial intelligence to shift many processes into the digital world and are working on making maintenance more predictive", reveals Markus Gschwandtner. Smart maintenance is a key lever for sustainability:

"In this way, customers currently already know what kind of maintenance measures will be required at specific points in the future. We create modules that bring even greater benefits to the customer." In addition to digital maintenance, these modules include e-learning offers through which customers can benefit even further from Brückner Servtec's knowledge and expertise.

Julia Spannring adds: "We're also planning to expand our remote maintenance, which is currently operated via video telephony. At present, we're testing augmented reality solutions, an exciting technology for which our systems are already equipped."

This is a promising vision of the future, as Markus Gschwandtner sums up: "Our solutions allow existing lines to be run at the highest uptime with minimal use of resources – and smart integrative maintenance."

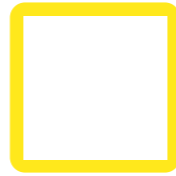

Brückner ONE supports film manufacturers with four modules.

Brückner ONE accelerates service processes and brings together specialists and customers worldwide.



Up to **25% recycled material** can be used.

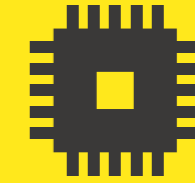

**25–30%**  
of energy can be saved by using new technologies.

The **four modules** of the digital service platform are under constant expansion – AR solutions are currently being tested.

The life of the line can be extended on average by **15** years.

The company is driving sustainability decisively through a combination of digital services and mechanical engineering solutions.





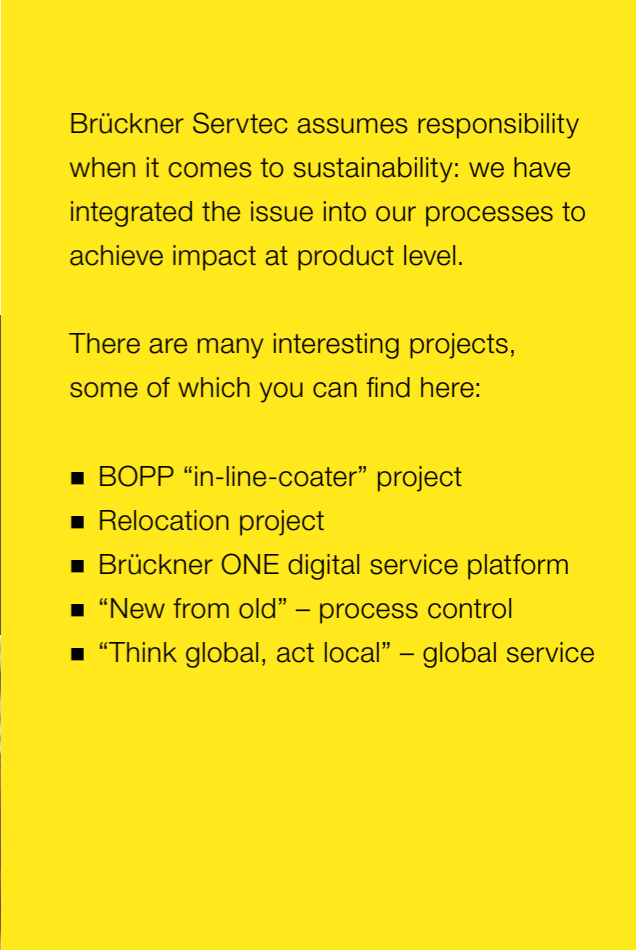
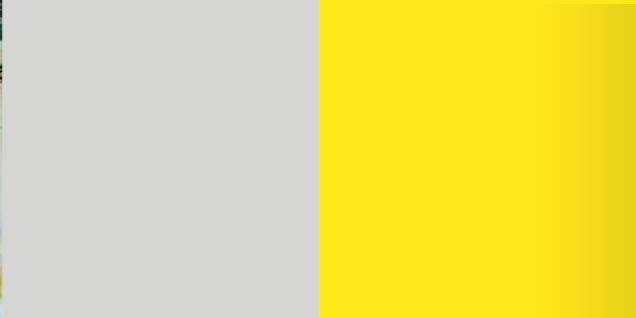

Brückner Servtec assumes responsibility when it comes to sustainability: we have integrated the issue into our processes to achieve impact at product level.

There are many interesting projects, some of which you can find here:

- BOPP “in-line-coater” project
- Relocation project
- Brückner ONE digital service platform
- “New from old” – process control
- “Think global, act local” – global service



**In the spotlight:**  
sustainability  
at Brückner  
Servtec





## How Kiefel promotes young talent and sustainability

With its combination of innovative power, expertise and a pioneering spirit, Kiefel is setting the tone when it comes to future technologies. To drive sustainability, it's crucial to be training tomorrow's skilled workers today. But what exactly is it that makes the company special? What is it that apprentices value? And what does Kiefel have in store for the future? Answers to these questions can be found by taking a look at the Kiefel training centre in Freilassing.

The future is already here: Kiefel is setting the tone in fibre thermoforming – and perpetuates this spirit of innovation through outstanding apprenticeships.

“When it comes to topics of the future, we're right at the forefront at our three sites in Freilassing, Micheldorf and Sprang-Capelle”, says Thomas Halletz, Managing Director of KIEFEL GmbH, proudly. “From digitalisation through robotics to automation: there's no avoiding these trends any longer – and the same goes for Kiefel.” Founded in 1945, the company is a global market leader among machine builders for the processing of plastics, bio-based materials and natural fibres. In the promising field of fibre thermoforming, Kiefel already offers great solutions. In operating its own Material R&D Center, Kiefel is continuously deepening its expertise in materials and decisively driving forward sustainability. With a focus on research, innovation and development, Kiefel has grown from a traditional mechanical engineering company into a holistic sustainability solutions provider. This also includes excellent support for young talent: in 2019, Kiefel opened its training centre, offering state-of-the-art working conditions over an area of more than 1,500m<sup>2</sup>. Kiefel was happy to make this investment, because “our performance, growth and success build on our specialists and managers”, says Thomas Halletz.



A career at Kiefel: what does this mean? Testimonies from apprentices at Freilassing.

#career



*"We're doers -  
and the WE is  
behind our success!"*



## Action!

**Thomas J. Halletz**  
CEO at Kiefel

Offering seven different apprenticeships and seven dual study courses, Kiefel sets the course for greater sustainability at the highest level. The training centre is impressive, with cutting-edge equipment and work tools including personal iPads for all apprentices. This is complemented by extensive training and tailored offers: junior staff have the opportunity to gain international experience, for one at Kiefel's subsidiaries outside Germany. In addition to technical training, the Kiefel Apprentice Academy also teaches their apprentices social and methodological skills as well as self-competence. With these key qualifications Kiefel lays the foundations for a strong workforce.

"The mindset of our employees is focused on innovation and development: where others may dwell on risks, we see opportunities. No other machine-building company has been able to develop new material competencies in the natural fibre sector as quickly as we have", summarises Cornelia Frank, Head of Marketing & Communications.

Kiefel enables their customers to use different materials, from recyclable plastics such as rPET to bio-based materials such as PLA and future solutions such as natural fibres. As a solutions provider, Kiefel is constantly rethinking materials, products, tools, processes and machines, so as to develop the best, as well as the most sustainable solution for each application. In doing so, Kiefel provides support to their customers and acts as a partner on their path to greater sustainability.



This drive to develop new solutions, pitch in and get involved runs through the entire company – as it has done quite literally for generations. Florian Weisel is not the only Weisel at Kiefel: his father Peter has worked for the company since October 1972. As Florian Weisel recalls, "what I learned about the company through my father convinced me too". For example, the levels of flexibility and personalised offers. Having successfully completed his apprenticeship as an electronics technician, Florian Weisel is now doing an additional apprenticeship as an industrial mechanic at Kiefel. "I wanted to take my education further", he explains, "It's great that Kiefel has given me the space to do so." In addition to these professional opportunities, he also appreciates the open and versatile environment: "At Kiefel, I can fully develop, evolve and contribute. They see and acknowledge me and my ideas."

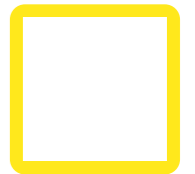

The Kiefel TEC TALKS address sustainability-related topics.



The Kiefel training centre in Freilassing is a central education hub.



Promoting young talent is close to Kiefel's heart.



**82**

of the current 580 employees are apprentices.

**13.5**

years average job tenure with the company

**99%**

apprentice retention rate

At the Kiefel training centre, employees from all Brückner group companies are offered training.







What happens in Freilassing does not stay in Freilassing. That's why Kiefel assumes responsibility when it comes to sustainability: from new buildings to natural fibres – a lot is happening here.

- New Material R&D Center in 2021
- New machinery for the natural fibres market
- Training centre for seven different apprenticeships
- Reduction of the carbon footprint of machinery
- Intelligent solutions for greater energy efficiency
- More line and resource efficiency through digital control
- Digital labelling of products to improve recyclability

**In the spotlight:**  
sustainability  
at Kiefel





## Creativity for greater sustainability: the KREA Lab Centre

In the EU, from 2024 onwards bottle caps must be firmly attached to the bottles. The purpose of these “tethered closures” is to prevent environmental pollution. A small piece of plastic, but a big task: how can PackSys Global, together with customers, implement technical solutions – thereby making a decisive contribution to greater sustainability.

Close your eyes and visualise a PET bottle. You probably have an image in your mind. While it may vary in colour or shape, the general principle is simple: a bottle consists of a container and a top, for example a screw cap. And precisely this small piece of plastic brings our thought experiment to an end, as from July 2024 the separation between bottle and top that you probably visualised will be a thing of the past. A new EU directive mandates that plastic caps remain attached to disposable drink containers after opening. The aim is to prevent environmental pollution caused by discarded unscrewed bottle tops. A laudable goal, presenting a big challenge for companies, who have to rethink and optimise their packaging designs – and subsequently implement these adjustments: “Policy-makers drew up the directive, the industrial sector developed creative solutions and we implemented the innovative process technologies – acting together to protect the environment”, explains Ueli Kobel, International Sales & Product Manager Beverage & Specialities Division at PackSys Global.

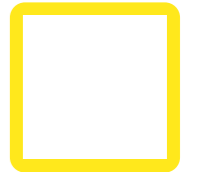

TEM: the new roll cutter/  
folding machine for speciality  
closures

Innovation to prevent plastic from entering the environment: how PackSys Global helps customers implement the EU directive.

#creative



“We not only want to contribute to sustainability, but indeed, we have to”, adds Beat Rupp, CEO of PackSys Global. This statement sums up the urgency of finding more sustainable solutions in the packaging sector. Time is, after all, of essence: Europe is to become the first climate-neutral continent by 2050; at the same time, the amount of packaging waste generated in the EU reached record levels in 2017. Consequently, the EU directive also targets single-use plastic products – and is making so-called “tethered beverage container closures” mandatory from 2024.

#### **KREA Lab Centre: a place for creativity and concrete results**

In the year the EU directive was passed, PackSys Global also opened its new headquarters in Rüti, Canton Zurich, Switzerland. In its construction, the focus was on building more sustainably, resulting in a saving of around 1,960m<sup>3</sup> of concrete. In addition, a photovoltaic system generates about 70 percent of the new building’s electricity requirements, and the Swiss company obtains the remaining energy from renewable sources.

These headquarters are home to a very special place – the KREA Lab Centre. Here, engineers, customers and the PackSys Global R&D teams can machine test new technologies and all available materials. The KREA Lab Centre provides a space for trying out, developing and testing new ideas,

as well as demonstrating innovations. It is precisely here that new products and production methods are created. For customers, the lab offers not only concrete results but also exciting insights into PackSys Global’s work processes. “At the KREA Lab Centre, we offer our customers ideal conditions for pursuing future projects and thus to develop themselves and their products”, Beat Rupp summarises – and this includes implementing the EU directive on tethered caps.

The challenge? Meeting even greater requirements while avoiding any increase in material input.

PackSys Global went to work at the KREA Lab Centre. The result? Impressive. After many years of intensive research, PackSys Global has developed new cutting technologies:

oriented cutting (CapCompass), multiple cutting (smarTether) and contour cutting (experTether) allow existing cap designs to be manufactured on existing lines, meeting the new requirements. An all-around success story, as PackSys Global’s solution not only allows longer use of existing equipment, but combined with the new bottle neck standard can even result in saving material.

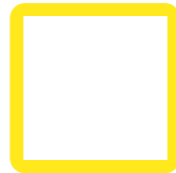

Ueli Kobel describes the technical innovation under creation at the KREA Lab Centre.

The new closures developed by PackSys Global together with external closure designers for a leading global beverage producer generates a reduction of about 10 percent of plastic input per PET bottle. And while the PackSys innovation team is satisfied with this result, it is merely the beginning: “As a technology partner, we’ll continue to give it our all in the future and actively support further optimisations so that fewer closures end up scattered around the environment”, says Ueli Kobel. In this process, the KREA Lab Centre will also act as a hub for other sustainable developments, including for customers from other industries. “We develop, test and sample products in the field of packaging for the cosmetics, pharmaceutical, beverage and speciality industries”, explains Ueli Kobel. This gives PackSys Global substantial leverage to work towards greater sustainability across all industries. This is a responsibility and a challenge that the Swiss are meeting with confidence, creativity and know-how: “We can do it!”



Room for innovation: new solutions are being developed and tested in the KREA Lab Centre.



*"We'll actively support further optimisations in the future so that fewer closures end up scattered around the environment."*

## Energy!

**Ueli Kobel**

International Sales & Product Manager  
Beverage & Specialities Division



Students from national and international universities travel to the KREA Lab Centre for visits and to conduct research.

# 70%

of the energy requirements can be generated maximally by the PV system at headquarters.

The new closures save around  
**10%**  
of plastic per bottle.

# 1,960m<sup>3</sup>

of concrete were saved during construction.

Innovative solutions are created in the KREA Lab Centre – while the building itself also stands out in terms of sustainability.





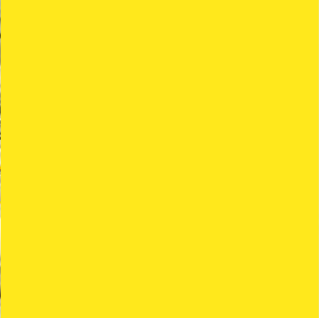
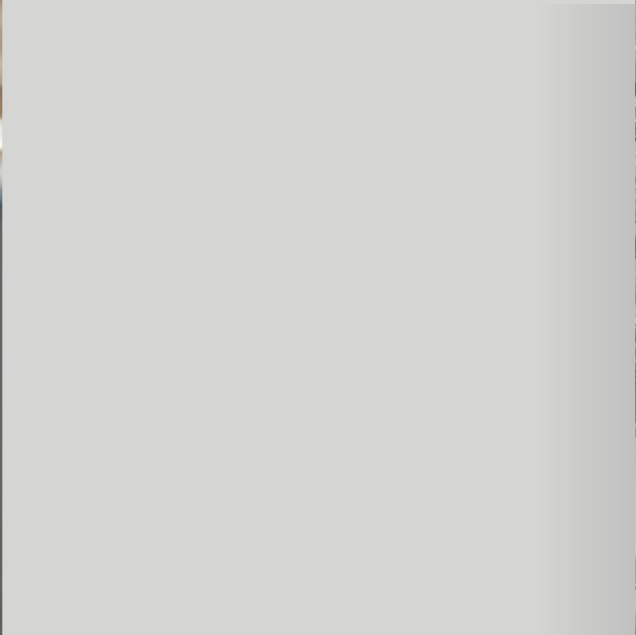

**In the spotlight:**  
Sustainability at  
PackSys Global

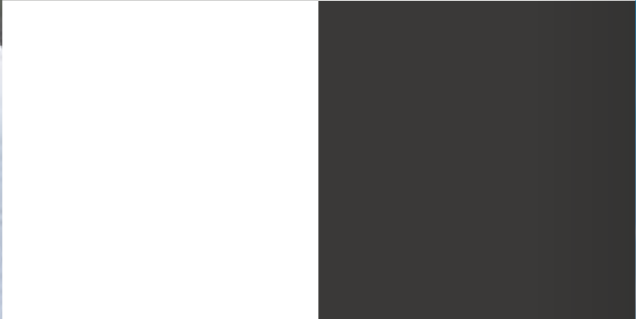

PackSys Global in Rüti, Canton Zurich, is already living a sustainable future: employees call the new environmentally friendly headquarters “the little Silicon Valley”. From its new design to saving tons of plastic through innovative solutions, there are already numerous opportunities – and this is merely the beginning.

There are many interesting projects, some of which you can find here:

- Tethered Beverage Container Closures
- New, “Swisstainable” head office in Rüti, Canton Zurich
- KREA Lab Centre for the development of sustainable solutions

## Imprint

### **Brückner Group GmbH**

Königsberger Str. 5–7  
83313 Siegsdorf  
Germany

Phone +49 8662 63-0  
communication@brueckner.com  
www.brueckner.com

### **Brückner Maschinenbau GmbH & Co. KG**

Königsberger Str. 5–7  
83313 Siegsdorf  
Germany

### **Brückner Servtec GmbH**

Königsberger Str. 5–7  
83313 Siegsdorf  
Germany

### **KIEFEL GmbH**

Sudetenstraße 3  
83395 Freilassing  
Germany

### **PackSys Global AG**

Spitalstrasse 38  
8630 Rüti  
Switzerland

### **Picture credits**

All pictures © Studio Weissbacher,  
www.studio-weissbacher.com and  
© Michael Sute, www.lightmoment.ch  
and p. 6 @ Adobe Stock, Wirestock;  
p. 23 © shutterstock.com, WDG Photo;  
p. 30 @ shutterstock.com, Yalcin Sonat

Find out more about sustainability  
in the Brückner Group here.

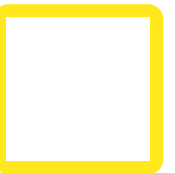



[www.brueckner.com](http://www.brueckner.com)

